

CURVED Head

WALL

OLIGO Lichttechnik GmbH
Tannenweg 1
DE - 53757 Sankt Augustin
Germany
www.oligo.de
info@oligo.de







Art.-Nr. / Item-No.
70-845-20-XX

Dieses Produkt enthält Lichtquellen der Energieeffizienzklasse F

(D)	Leuchtmittel nicht ersetzbar
(GB)	Bulbs not replaceable
(NL)	Lamp niet vervangbaar
(F)	Ampoules non remplaçables
(I)	Lampadina non sostituibile
(ES)	Bombillas no reemplazables
(P)	Lâmpada não substituível
(DK)	Ljuskällorna kan inte bytas ut

(S)	Bulb inte utbytbara
(N)	Lyspærer kan ikke skiftes ut
(FI)	Vallistusvälinettä ei voi vaihtaa
(TR)	Ampuller değiştirilemez
(PL)	Źródło światła nie jest wymienne
(GR)	Οι λαμπτήρες δεν αντικαθίστανται
(RUS)	Светодиоды не поддаются замене
(UAE)	تجهيزات الإضاءة غير قابلة للاستبدال

	DC 24V SELV	max. 22W standby : <150mW	LED / 1600lm / 2200-5000K / CRI-Ra >90
(D)	Spannung	Belastung	Lampe
(GB)	Voltage	Loading	Bulb
(NL)	Spanning	Belasting	Verlichtingsmiddel
(F)	Tension	Charge	Ampoule
(I)	Tensione	Carico	Sorgente luminosa
(ES)	Tensión	Carga	Lámpara
(P)	Tensão	Carga	Lâmpada
(DK)	Spænding	Belastning	Pære
(S)	Spänning	Belastning	Ljuskälla
(N)	Spennning	Fatning	Lampe
(FI)	Jännite	Kuormitus	Lamppu
(TR)	Gerilim	Yük	Lamba
(PL)	Napięcie	Oprawka	Lampa
(GR)	Τάση	Υποδοχή	Λαμπτήρας
(RUS)	Напряжение	Нагрузка	Лампочка
(UAE)	الجهد الكهربى	الدواة	المصباح

	
IEC 62471 (EN 62471) RG1 - LOW RISK	
CASAMBI	
	
	
	

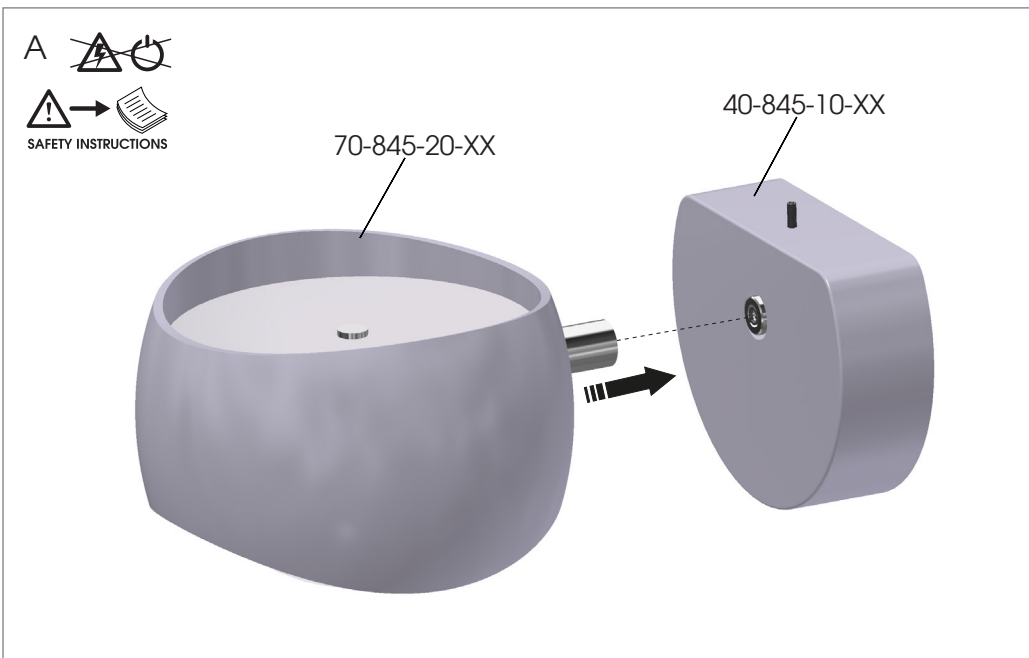

2200 – 5000 K

Lichtfarbe und Helligkeit können ausschließlich über die Casambi APP gesteuert werden.

The colour of light and luminous intensity can only be controlled by Casambi APP.

Technische Daten

Funk:
 Frequenz: 2,4 GHz
 max. Leistung: +4 dBm (< 2,6 mW)

Voraussetzungen für den Betrieb*

- SMART DEVICE mit iOS oder Android
- CASAMBI APP

Eine detaillierte Bedienungsanleitung zur CASAMBI APP finden Sie unter www.oligo.de oder www.casambi.com

* Bitte stellen Sie sicher, dass auf allen Komponenten (z. B. SMART DEVICE, CASAMBI APP, Leuchte) die aktuelle Software installiert ist.

Technical Data

Radio:
 Frequency: 2,4 GHz
 max. power: +4 dBm (< 2,6 mW)

Requirements for operation*

- SMART DEVICE with iOS or Android
- CASAMBI APP

For detailed instructions regarding the CASAMBI APP, see www.oligo.de or www.casambi.com

* Please ensure that the current software is installed on all components (e. g. SMART DEVICE, CASAMBI APP, luminaire).

Contains FCC ID: 2ALA3-CBM002A Contains IC: 22496-CBM002A

This device complies with part 15 of the FCC Rules. Operation is subject to the following two conditions:
 (1) This device may not cause harmful interference, and
 (2) this device must accept any interference received, including interference that may cause undesired operation.

This device complies with Industry Canada's licenseexempt RSSs. Operation is subject to the following two conditions:
 (1) This device may not cause interference; and
 (2) This device must accept any interference, including interference that may cause undesired operation of the device.

Le présent appareil est conforme aux CNR d'Industrie Canada applicables aux appareils radio exempts de licence. L'exploitation est autorisée aux deux conditions suivantes:
 (1) l'appareil ne doit pas produire de brouillage;
 (2) l'utilisateur de l'appareil doit accepter tout brouillage radioélectrique subi, même si le brouillage est susceptible d'en compromettre le fonctionnement.