

ROCKET PL

CHECK-IN

OLIGO Lichttechnik GmbH
Tannenweg 1
DE - 53757 Sankt Augustin
Germany
www.oligo.de
info@oligo.de







Art.-Nr. / Item-No.
30-853-21-XX

Dieses Produkt enthält eine Lichtquelle des Typs Edison Opto Corp. Ltd., DOB III 5DATCN9023082704 der Energieeffizienzklasse G.

(D)	Leuchtmittel nicht ersetzbar
(GB)	Bulbs not replaceable
(NL)	Lamp niet vervangbaar
(F)	Ampoules non remplaçables
(I)	Lampadina non sostituibile
(ES)	Bombillas no reemplazables
(P)	Lâmpada não substituível
(DK)	Ljuskällorna kan inte bytas ut

(S)	Bulb inte utbytbara
(N)	Lyspærer kan ikke skiftes ut
(FI)	Valistusvälinettä ei voi vaihtaa
(TR)	Ampuller değiştirilemez
(PL)	Źródło światła nie jest wymienne
(GR)	Οι λαμπτήρες δεν αντικαθίστανται
(RUS)	Светодиоды не поддаются замене
(UAE)	تجهيزات الإضاءة غير قابلة للاستبدال

	AC 230V / 50-60Hz	8W	LED / 2700K / 450lm / CRI >90
(D)	Spannung	Belastung	Lampe
(GB)	Voltage	Loading	Bulb
(NL)	Spanning	Belasting	Verlichtingsmiddel
(F)	Tension	Charge	Ampoule
(I)	Tensione	Carico	Sorgente luminosa
(ES)	Tensión	Carga	Lámpara
(P)	Tensão	Carga	Lâmpada
(DK)	Spænding	Belastning	Pære
(S)	Spänning	Belastning	Ljuskälla
(N)	Spenning	Fatning	Lampe
(FI)	Jännite	Kuormitus	Lamppu
(TR)	Gerilim	Yük	Lamba
(PL)	Napięcie	Oprawka	Lampa
(GR)	Τάση	Υποδοχή	Λαμπτήρας
(RUS)	Напряжение	Нагрузка	Лампочка
(UAE)	الجهد الكهربى	الدواة	المصباح

	
IEC 62471 (EN 62471) RG1 - LOW RISK	
	
	

A

SAFETY INSTRUCTIONS

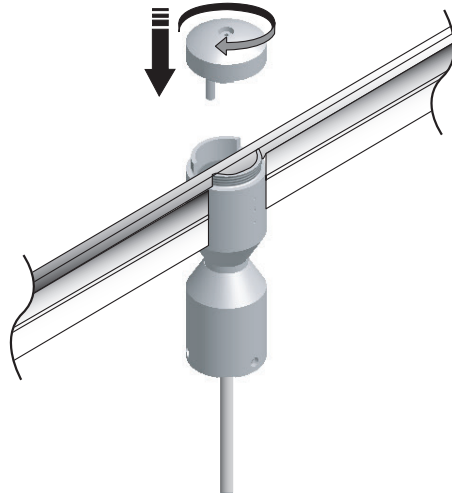

B

