

SENTRY

SMART.POINT System

Art.-Nr. / Item-No.

20-867-6X-YY 2700K

20-867-7X-YY 3000K

20-867-8X-YY 4000K

OLIGO Lichttechnik GmbH

Tannenweg 1

DE - 53757 Sankt Augustin

Germany

www.oligo.de











info@oligo.de

Dieses Produkt enthält Lichtquelle/n des Typs Citizen Electronics Co., LTD.,
CLU711-1204C4-273H5K2 / CLU711-1204C4-303H5K2 der Energieeffizienzklasse F.

(D)	Leuchtmittel nicht ersetzbar
(GB)	Bulbs not replaceable
(NL)	Lamp niet vervangbaar
(F)	Ampoules non remplaçables
(I)	Lampadina non sostituibile
(ES)	Bombillas no reemplazables
(P)	Lâmpada não substituível
(DK)	Ljuskällorna kan inte bytas ut

(S)	Bulb inte utbytbara
(N)	Lyspærer kan ikke skiftes ut
(FI)	Valistusvälinettä ei voi vaihtaa
(TR)	Ampuller değiştirilemez
(PL)	Źródło światła nie jest wymienne
(GR)	Οι λαμπτήρες δεν αντικαθίστανται
(RUS)	Светодиоды не поддаются замене
(UAE)	تجهيزات الإضاءة غير قابلة للاستبدال

	DC 24V	13,9 W	LED / CRI - RA >90 / 1150 lm
(D)	Spannung	Belastung	Lampe
(GB)	Voltage	Loading	Bulb
(NL)	Spanning	Belasting	Verlichtingsmiddel
(F)	Tension	Charge	Ampoule
(I)	Tensione	Carico	Sorgente luminosa
(ES)	Tensión	Carga	Lámpara
(P)	Tensão	Carga	Lâmpada
(DK)	Spænding	Belastning	Pære
(S)	Spänning	Belastning	Ljuskälla
(N)	Spenning	Fatning	Lampe
(FI)	Jännite	Kuormitus	Lamppu
(TR)	Gerilim	Yük	Lamba
(PL)	Napięcie	Oprawka	Lampa
(GR)	Τάση	Υποδοχή	Λαμπτήρας
(RUS)	Напряжение	Нагрузка	Лампочка
(UAE)	الجهد الكهربى	الدواة	المصباح

	
IEC 62471 (EN 62471) RG1 - LOW RISK	
	
option	HomeMatic CASAMBI
	
	
	

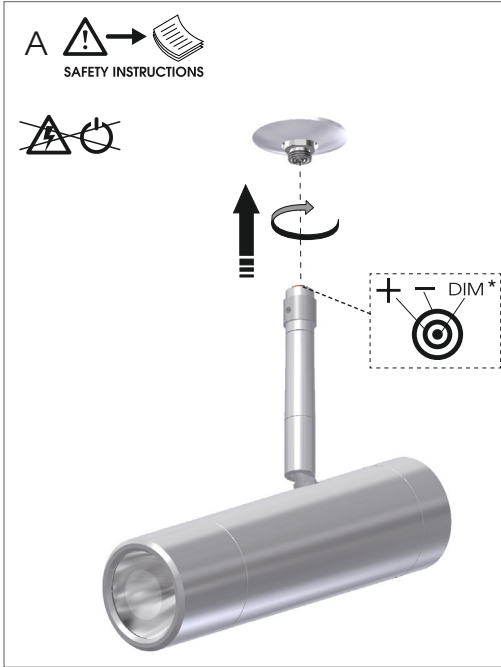

DALI READY

OPTION SMART.POINT : 60-311-10-00 DALI CONVERTER
OPTION PHASE : D33-624-10-XX DC 24V DALI ADAPTER

HomeMatic READY

OPTION SMART.POINT : 60-312-11-00 HM RF-MODULE
OPTION SMART.TRACK : 23-625-11-XX HM IQ-MODULE

CASAMBI READY
Bluetooth 4.0 LE

OPTION SMART.POINT : 60-312-10-00 BT RF-MODULE
OPTION SMART.TRACK : 23-625-10-XX BT IQ-MODULE

*** DIM** READY

Open Collector / PWM max.20kHz / 5mA / max. DC 24V
OC Active High / >3V = ON / <2V = OFF / min. Duty Cycle >1μs

SENTRY

SMART.POINT System

Art.-Nr. / Item-No.

20-867-6X-YY 2700K

20-867-7X-YY 3000K

20-867-8X-YY 4000K

OLIGO Lichttechnik GmbH

Tannenweg 1

DE - 53757 Sankt Augustin

Germany

www.oligo.de











info@oligo.de

Dieses Produkt enthält Lichtquelle/n des Typs Citizen Electronics Co., LTD.,
CLU711-1204C4-273H5K2 / CLU711-1204C4-303H5K2 der Energieeffizienzklasse F.

(D)	Leuchtmittel nicht ersetzbar
(GB)	Bulbs not replaceable
(NL)	Lamp niet vervangbaar
(F)	Ampoules non remplaçables
(I)	Lampadina non sostituibile
(ES)	Bombillas no reemplazables
(P)	Lâmpada não substituível
(DK)	Ljuskällorna kan inte bytas ut

(S)	Bulb inte utbytbara
(N)	Lyspærer kan ikke skiftes ut
(FI)	Valistusvälinettä ei voi vaihtaa
(TR)	Ampuller değiştirilemez
(PL)	Źródło światła nie jest wymienne
(GR)	Οι λαμπτήρες δεν αντικαθίστανται
(RUS)	Светодиоды не поддаются замене
(UAE)	تجهيزات الإضاءة غير قابلة للاستبدال

	DC 24V	13,9 W	LED / CRI - RA >90 / 1150 lm
(D)	Spannung	Belastung	Lampe
(GB)	Voltage	Loading	Bulb
(NL)	Spanning	Belasting	Verlichtingsmiddel
(F)	Tension	Charge	Ampoule
(I)	Tensione	Carico	Sorgente luminosa
(ES)	Tensión	Carga	Lámpara
(P)	Tensão	Carga	Lâmpada
(DK)	Spænding	Belastning	Pære
(S)	Spänning	Belastning	Ljuskälla
(N)	Spenning	Fatning	Lampe
(FI)	Jännite	Kuormitus	Lamppu
(TR)	Gerilim	Yük	Lamba
(PL)	Napięcie	Oprawka	Lampa
(GR)	Τάση	Υποδοχή	Λαμπτήρας
(RUS)	Напряжение	Нагрузка	Лампочка
(UAE)	الجهد الكهربى	الدواة	المصباح

	
IEC 62471 (EN 62471) RG1 - LOW RISK	
	
option	HomeMatic CASAMBI
	
	
	

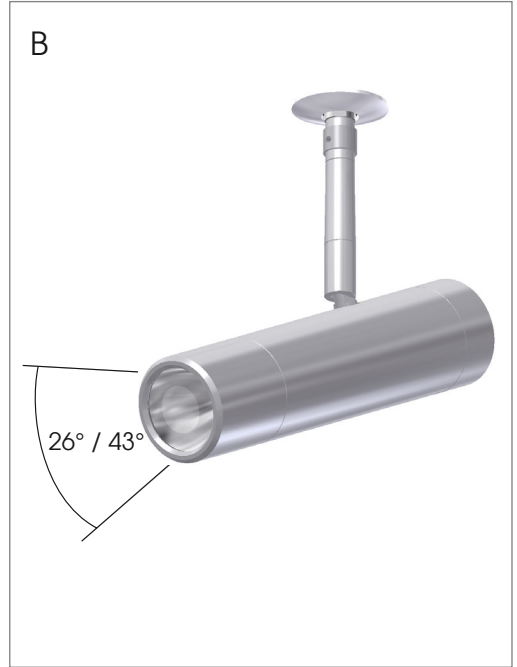
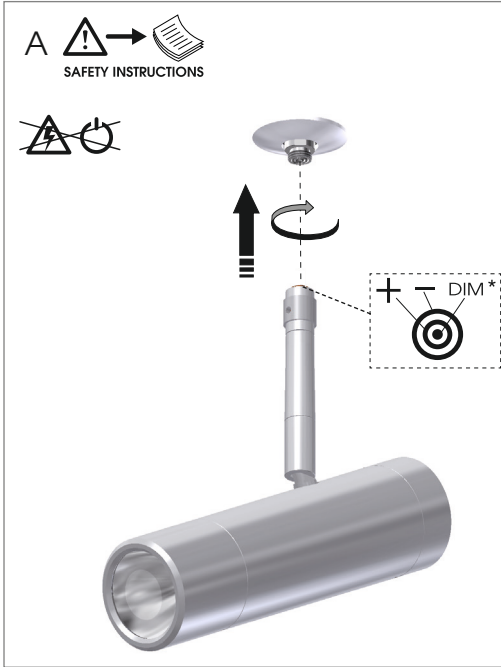

DALI READY

OPTION SMART.POINT : 60-311-10-00 DALI CONVERTER
OPTION PHASE : D33-624-10-XX DC 24V DALI ADAPTER

HomeMatic READY

OPTION SMART.POINT : 60-312-11-00 HM RF-MODULE
OPTION SMART.TRACK : 23-625-11-XX HM IQ-MODULE

CASAMBI READY
Bluetooth 4.0 LE

OPTION SMART.POINT : 60-312-10-00 BT RF-MODULE
OPTION SMART.TRACK : 23-625-10-XX BT IQ-MODULE

*** DIM** READY

Open Collector / PWM max.20kHz / 5mA / max. DC 24V
OC Active High / >3V = ON / <2V = OFF / min. Duty Cycle >1μs